

UXIA Pata metálica
H90 L250

UXIA Pata metálica
H120 L150

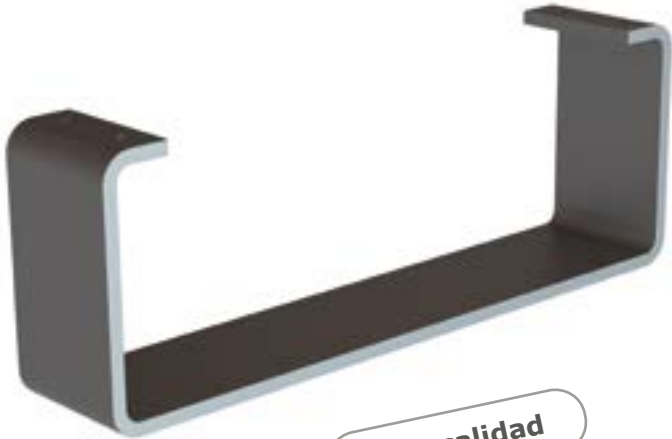

Alta calidad



Alta calidad

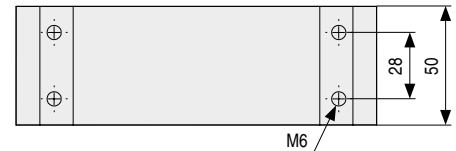
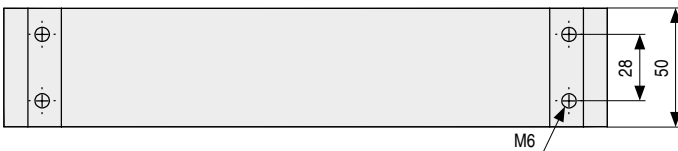
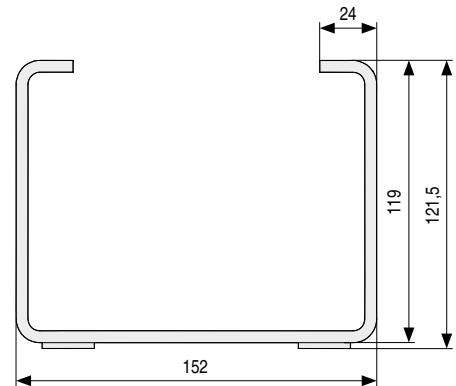
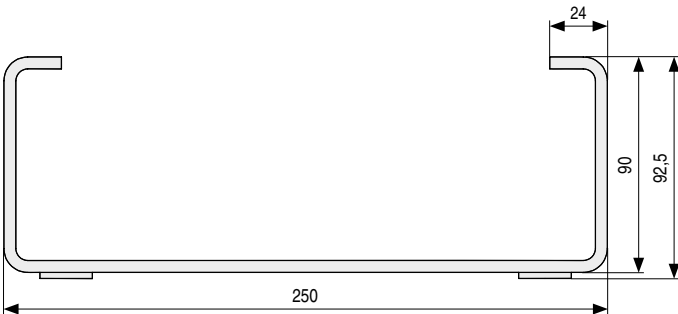

• Códigos con letra **V**, se piden por encargo.

UXIA H90 L250

CÓDIGO	Material	Acabado	
9034.701	hierro	chromo	20
9034.703	hierro	blanco mate	20
9034.705	hierro	gris plata	20
9034.707	hierro	gris metalizado	20
9034.709V	hierro	verde lima	20
9034.711	hierro	antracita	20
9034.713	hierro	gris mate	20
9034.715V	hierro	mandarina	20
9034.717	hierro	oro metalizado	20
9034.719	hierro	malva	20
9034.721V	hierro	marrón metalizado	20

• Códigos con letra **V**, se piden por encargo.

UXIA H120 L150

CÓDIGO	Material	Acabado	
9034.702	hierro	chromo	20
9034.704	hierro	blanco mate	20
9034.706	hierro	gris plata	20
9034.708	hierro	gris metalizado	20
9034.710V	hierro	verde lima	20
9034.712	hierro	antracita	20
9034.714	hierro	gris mate	20
9034.716V	hierro	mandarina	20
9034.718	hierro	oro metalizado	20
9034.720	hierro	malva	20
9034.722V	hierro	marrón metalizado	20